

Canto USA is the trusted name in modern followspots. Bright, modular, and ease of use are the trademarks of this line of units that can go anywhere and perform multiple tasks. The design is simple and elegant with ergonomic handling and easy to understand labeling. It's all-in-one ordering system guarantees that the unit is delivered with everything needed and begin your show. Canto USA followspots are great for large format situations like arenas, stadiums and large theatres.



Whats in the Box

- Follow Spot Fixture
- Douser
- Sizing Iris
- Gobo Insert
- LED Engine
- HD Bearing Head Tripod
- 7 Color Boomerang
- Power Cable
- High Definition Optical Tray
- Assurance that it works!



Accessories/Options

- Spare Iris Diaphragm
- Spare 7 Color Boomerang
- Black Stand Tripod
- TelRad

Unit Stats

- Internal Ballast
- 120V-240V
- **90 CRI Model**
Stand By Power: 0.47Amps
LED Full Power with Fans at 100%:
7.7 Amps (@120VAC = 924 Watts)
- Head 132 lbs
Yoke Assembly: 36 lbs
Tripod: 26 lbs

Light Source: LED CoB

LED	6000K	90 CRI	20000 Hours
-----	-------	--------	-------------

Dimensions

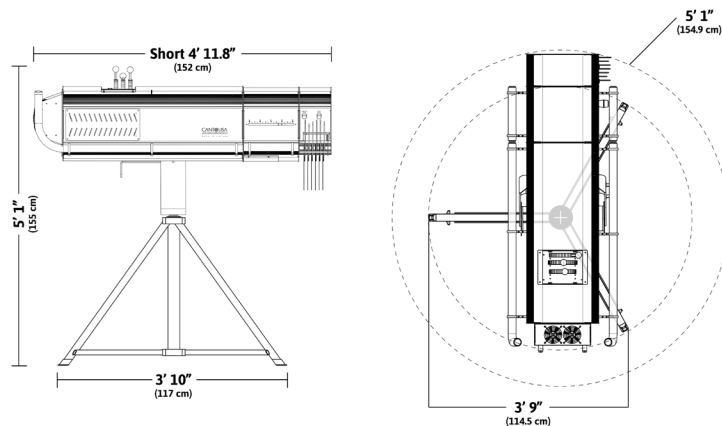

Photometrics Foot Candles/Ft

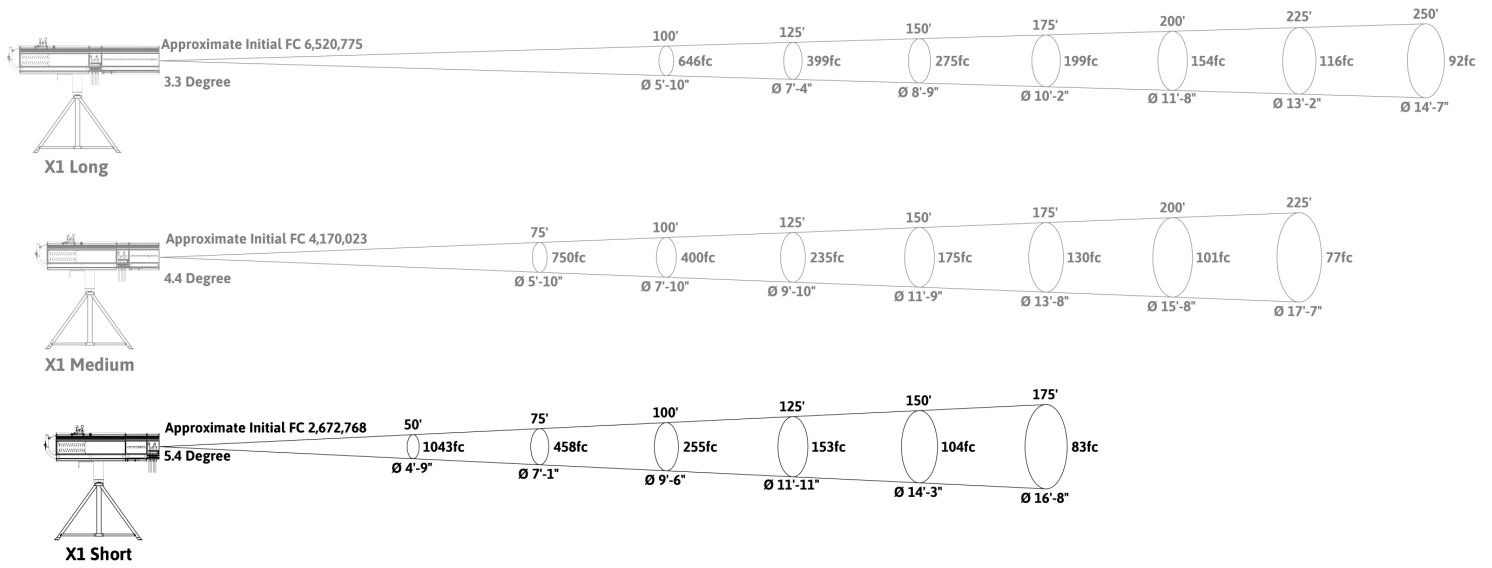

Photometrics Lux/M

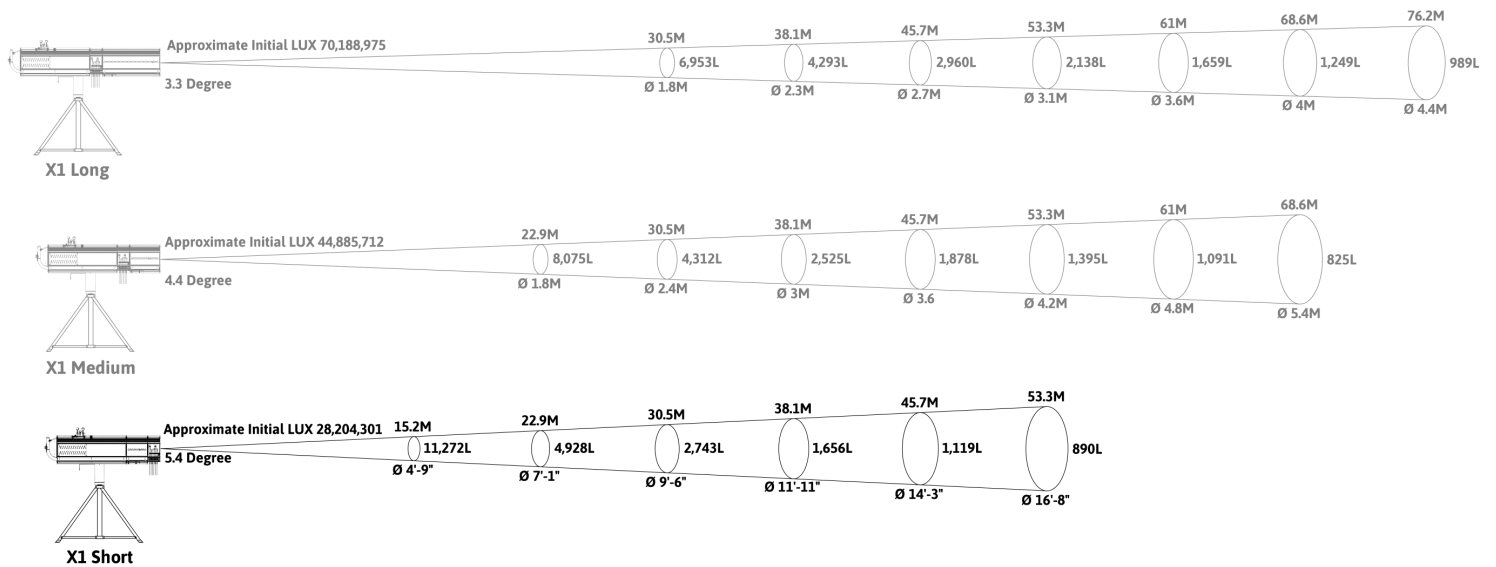

- * Photometrics are an average of 3 readings taken in a real world small theater application.
- * Light readings measured with a Sekonic C-700 U Spectromaster Color Meter.
- * Measurements were taken with a new fixture.