

CANTO is the trusted name in modern follow spots. Bright, modular, and ease of use are the trademarks of this economical line of units that can go anywhere and perform multiple tasks. The Italian design is simple and elegant with ergonomic handling and easy to understand labeling. It's all-in-one ordering system guarantees that the unit is delivered with everything needed to plug the fixture into the wall and begin your show. Canto followspots are great for schools, universities, professional theater, touring and houses of worship.

Whats in the Box

- Follow Spot Fixture
- Iris
- Lamp
- Tripod Stand
- 6 Color Boomerang
- Electronic Power Supply
- Cable for Supply to Head
- Power Cable
- 15 Amp Edison
- 7.25" Round Gel Pack (5 Colors)
- 28mm Spigot
- Assurance that it works!
- Handle Mount Dimming Slide
- DMX Dimming In/Out
- Power In/Out

Accessories/Options

- Additional Color Frames
- Gobo Holder (A or B)
- Spare 6 Color Boomerang
- Black Stand Tripod
- Tripod Casters
- Custom Flight Case
- Custom Permanent Floor Stand
- Truss Mount Pan Bearing Adaptor
- Over Hung Yoke
- 28mm Spigot
- TelRad
- Shutter Blades
- Professional Tripod Stand

Unit Stats

- Double Condenser+ Zoom
- LED 6000K Cool White Standard
3200K on Request
- Internal Ballast
- 8° to 16° Zoom
- 120V-240V
- Head 44 lbs.

**10 Year
LED Array
Warranty**



Lamp Types

LED	3000K or 6000K	50000 Hours LM70
-----	----------------	------------------

Dimensions

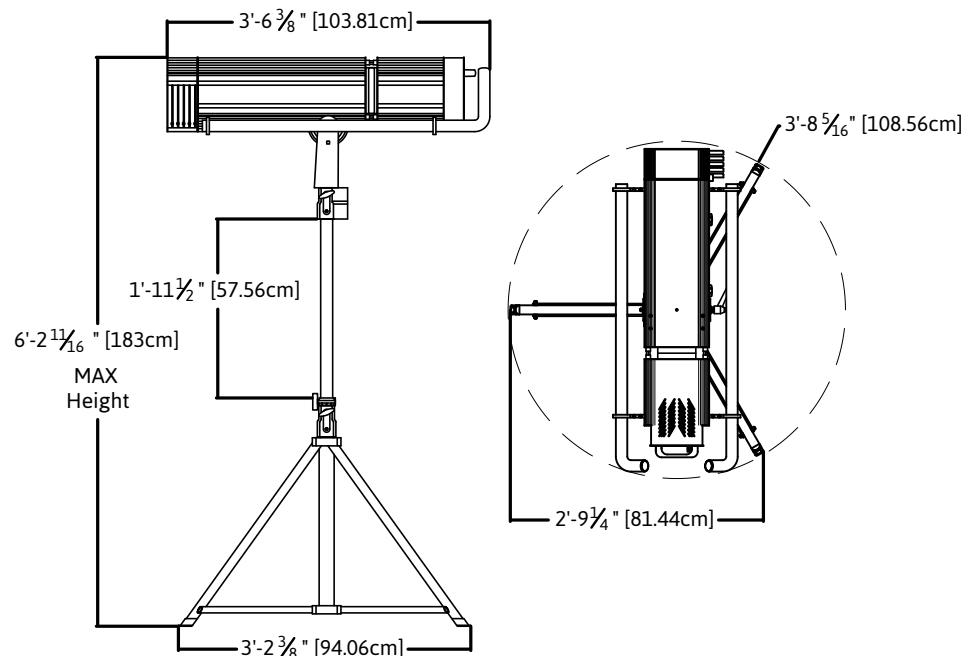

Photometrics Foot Candles/Ft

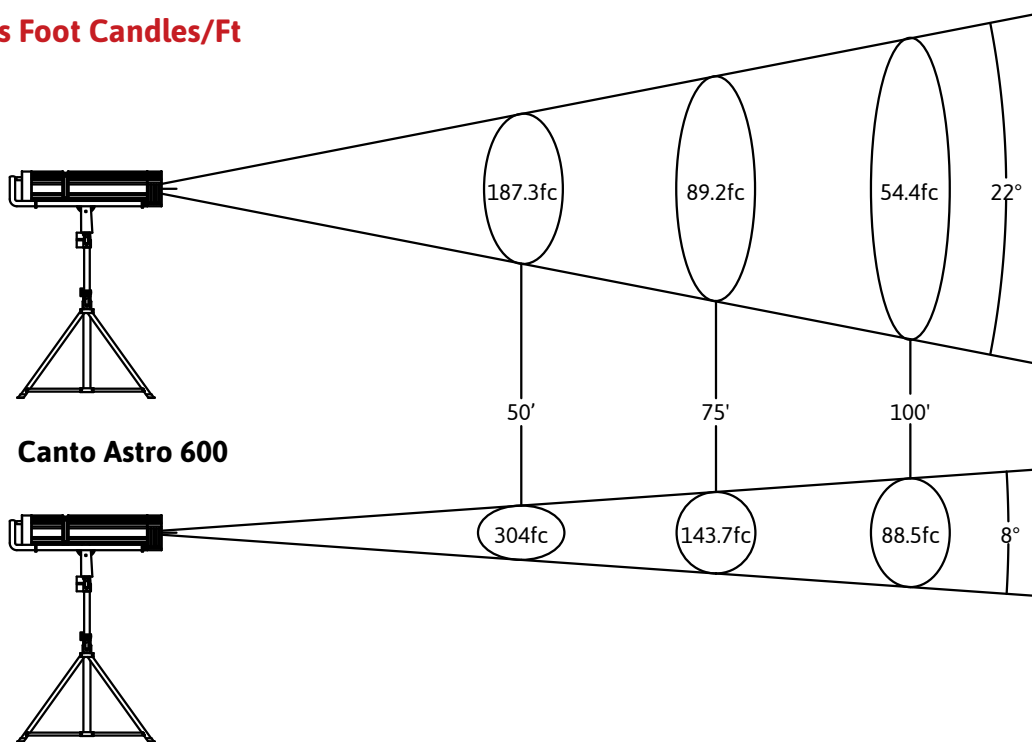

Photometrics Lux/M

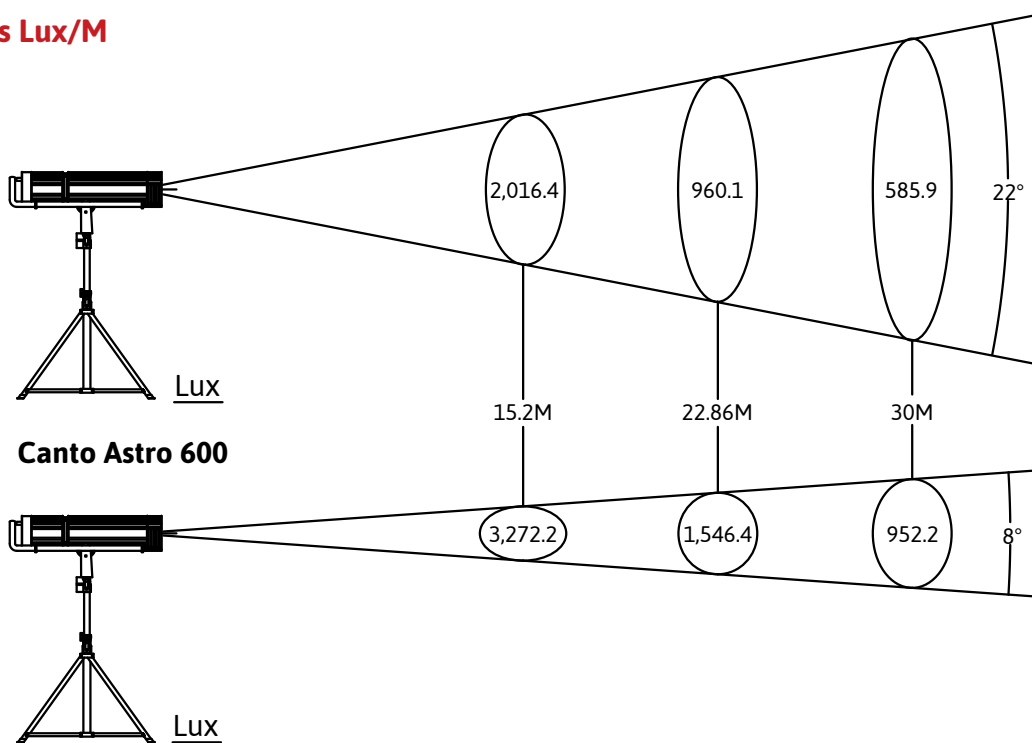

* Photometrics are an average of 3 readings taken in a real world small theater application.
 * Light readings measured with a Sekonic C-700 U Spectromaster Color Meter.
 * Measurements were taken with a new fixture.