



# AXT600

## Spectrum Manager

Manual for the Shure Axient Spectrum Manager (AXT600).  
Version: 4 (2019-L)

# Table of Contents

<b>AXT600Spectrum Manager</b>	<b>3</b>	<b>Exclusions</b>	<b>12</b>
		Entering Exclusions	12
<b>General Description</b>	<b>3</b>	<b>Event Log</b>	<b>12</b>
Features	3	<b>Spectrum Monitoring</b>	<b>13</b>
<b>Front Panel</b>	<b>4</b>	Backup Frequency Monitoring	13
Rear Panel	5	Listen	14
<b>Connecting Antennas</b>	<b>6</b>	Scanning	14
<b>Mounting Instructions</b>	<b>6</b>	<b>Setting the Fan Speed</b>	<b>15</b>
<b>Home Menu Screen</b>	<b>6</b>	<b>Firmware Updates</b>	<b>16</b>
Data Display Screen	8	<b>Specifications</b>	<b>16</b>
<b>Networking a Spectrum Manager and Receivers</b>	<b>8</b>	Scan Time	17
Automatic IP Addressing	9	RF Input	17
Manual IP Addressing	9	Networking	18
Device Reset	9	<b>Accessories</b>	<b>18</b>
Troubleshooting	9	Furnished Accessories	18
Network Access Control	10	<b>Information to the user</b>	<b>19</b>
<b>RF Coordination Wizard</b>	<b>10</b>	IMPORTANT SAFETY INSTRUCTIONS	19
All New	10	WARNING FOR ALL EARPHONES!	20
Update Freqs	10	WARNING	21
Update Devices	11	<b>Certifications</b>	<b>21</b>
Using All New Wizard Option for System Setup	11		

---

# AXT600 Spectrum Manager

---

## General Description

The Axient Spectrum Manager is a powerful tool for calculating, analyzing and assigning compatible frequencies to wireless components. The Spectrum Manager scans the RF environment and uses this data to calculate compatible frequencies for all wireless channels found on the network. Networked wireless systems can be programmed from the Compatible Frequency List, while backup frequencies are continuously monitored and ranked according to quality. During operation, the Spectrum Manager deploys clear frequencies to receivers when interference occurs. Built-in spectrum monitoring tools provide visual and audio tracking of RF activity.

## Features

### Wideband Scanning

The Spectrum Manager captures scan data for the entire UHF frequency range available for wireless audio. The scan is compiled using two antenna inputs, with sensitivity and resolution that are directly applicable to wireless receivers.

### Compatible Frequency List

The Compatible Frequency List (CFL) is list of available frequencies that can be calculated, viewed, and edited from the Spectrum Manager or it can be generated from a computer running Wireless Workbench<sup>®</sup> 6. The on-board frequency calculator can be adjusted to avoid specific TV channels, frequency ranges or RF signal above a specified threshold. During operation the Spectrum Manager provides current status of each frequency in the list. Clear frequencies are deployed from the compatible frequency list to initially setup a system or to replace frequencies degraded by interference.

### Event Log

The *Event Log* records actions of the Spectrum Manager during operation. Actions include changes to frequencies and equipment controlled by the Spectrum Manager. Reviewing the event log after a performance provides a snapshot of system performance.

### Backup Frequency Monitoring

The data screen tracks the status of all frequencies available for Axient systems. The number of frequencies is displayed for each band, including real-time status of in-use and backup frequencies.

### RF Scanning

The scanning feature of the Spectrum Manager graphically plots the measured RF signal across the full frequency range. *Cursor*, *Zoom*, and *Peak* tools allow detailed inspection of the data.

### Listen

Use the *Listen* feature to tune to a frequency and monitor FM demodulated signal using headphones. The data screen displays the signal strength for the selected frequency.

## Networking

Networking enables many of the advanced features of the Axient system, including monitoring and control of remote devices. Rack components have two RJ45 Ethernet ports capable of 10/100 Mbps network speeds. The Ethernet ports are power over Ethernet (PoE) enabled to supply power to the ShowLink™ access point or other class 1 Ethernet devices.

## RF Cascade Ports

The cascade ports allow sharing of RF signal with up to 5 components without antenna splitters or distribution amplifiers.

## Front Panel

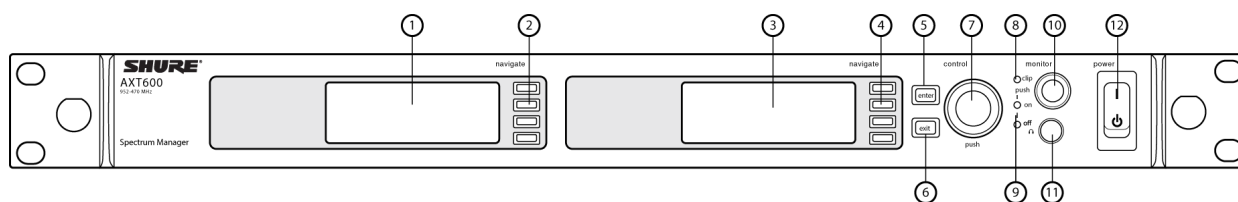

### ① Data display screen

Displays Frequency Monitoring status, RF plots, and signal strength.

### ② Data display navigation buttons

Use to access menu options.

### ③ Menu screen display

Displays menus and settings.

### ④ Menu navigation buttons

Use to select and navigate through menus.

### ⑤ Enter button

Use to enter and save parameter changes.

### ⑥ Exit button

Cancels parameter changes or returns to a previous menu screen.

### ⑦ Control wheel

- Push to select menu items for editing
- Turn to edit a parameter value

Tip: Press and hold the control wheel for 1 second to activate the Hardware Identify feature in WWB.

### ⑧ Monitor clip LED

Indicates audio overload when illuminated.

### ⑨ **Monitor output LED**

Indicates monitor output on or off.

### ⑩ **Monitor volume knob**

Adjusts monitor volume.

### ⑪ **Monitor jack**

6.5 mm (1/4") jack.

### ⑫ **Power switch**

Power the unit on or off.

## Rear Panel

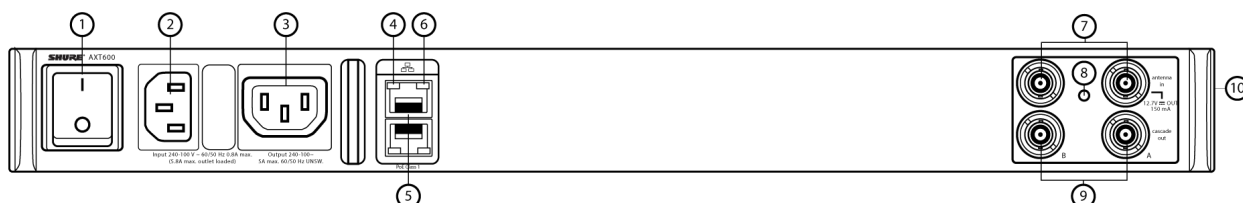

### ① **AC power primary switch**

AC main power switch.

### ② **AC power in**

IEC connector 100 - 240 V AC.

### ③ **AC power cascade**

Use IEC extension cables to connect up to 5 rack components to a single AC power source.

### ④ **Network speed LED (amber)**

- Off = 10 Mbps
- On = 100 Mbps

### ⑤ **Ethernet ports: Class 1 PoE enabled (2)**

Connect to an Ethernet network to enable remote control and monitoring.

### ⑥ **Network status LED (green)**

- Off = no network link
- On = network link active
- Flashing = network link active, flash rate corresponds to traffic volume

### ⑦ **RF antenna input jacks**

For antenna A and antenna B.

### ⑧ RF input status LED

Indicates the voltage status of the RF input.

- Green = DC voltage on
- Red flashing = fault condition
- Off = DC voltage off

### ⑨ RF cascade ports

Passes the RF signal to additional components.

### ⑩ Temperature activated fan

Ensures top performance in high temperature environments. Clean fan screen as needed to maintain airflow.

## Connecting Antennas

Two antennas allow the Spectrum Manager to capture scan data and analyze the RF signals used in diversity receiver applications. If active antennas are used, set *Antenna DC Power* to *On*.

To use front-mounted antennas:

1. Insert the bulkhead adapters on the supplied front-mounting cables through the holes in each bracket and secure them from the front using the supplied hardware.
2. Connect the supplied antenna cables to the antenna input BNC connectors on the rear panel.

## Mounting Instructions

This component is designed to fit into an audio rack.

**WARNING:** To prevent injury this apparatus must be securely attached to the rack.

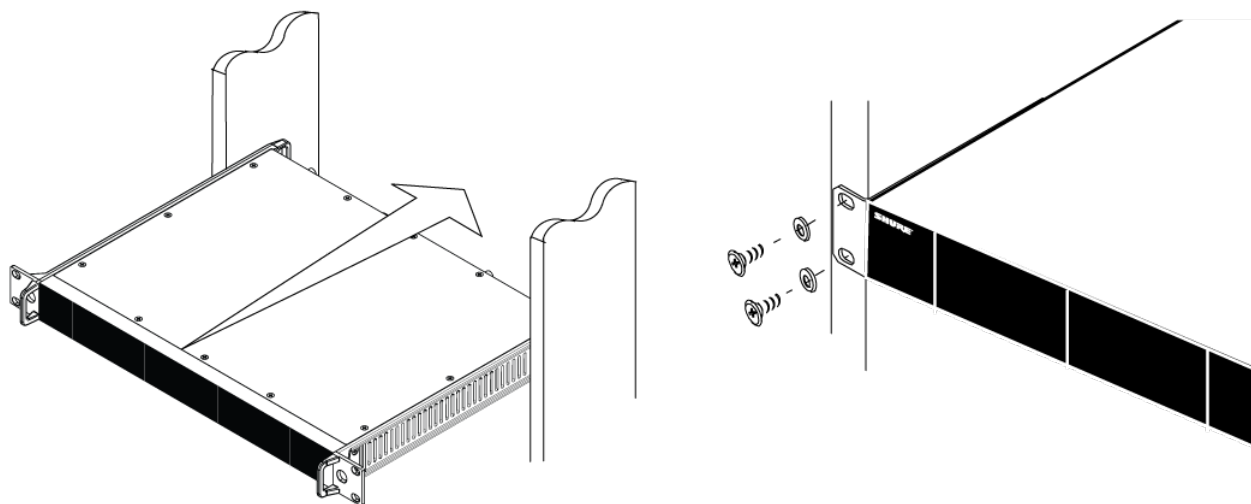

# Home Menu Screen

During operation, the home menu screen displays the following indicators:

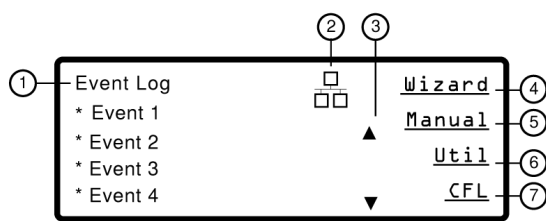

## ① Event Log

Records Spectrum Manager functions during operation.

## ② Network Icon

Indicates connectivity with other devices on the network.

**Note:** IP address must be valid to enable networked control.

## ③ Scroll Arrows

Indicates additional log entries listed above or below.

## ④ Wizard Sub-menu

Accesses the following wizard functions:

- All New
- Update Freqs
- Update Devices

## ⑤ Manual Sub-menu

Accesses the following menus:

- Devices
- Scans
- Listen

## ⑥ Util Sub-menu

Accesses the following menus:

- Display
- Network
- Lock
- More (fan, S/N, Reset All, User Group)

## ⑦ CFL Sub-menu

Accesses the following menus:

- New
- Edit

- *More* (including *Analyze* and *Clear*)
- *Deploy*

## ⑧ Network Access Control Icon

Displayed when Access Control PIN is enabled from Shure control software.

## Data Display Screen

During operation, the data display shows the backup frequency monitoring screen. When the *Scanning* function is active, the display shows the RF plot. When the *Listen* feature is active, the display shows a graphic representation of signal strength for a selected frequency.

Axient Frequency Monitoring					<a href="#">More</a> ④
① Band	G1	H4	J5	L3	
② In Use	6	10	4	6	
③ Ready	12	4	6	10	

### ① **Band**

Lists frequency bands for Axient devices controlled by the Spectrum Manager

### ② **In Use**

Lists the number of CFL frequencies used by devices controlled by the Spectrum Manager

### ③ **Ready**

Lists the number of frequencies that are currently clear and can be deployed

### ④ **More**

Indicates additional frequency band entries are available

## Networking a Spectrum Manager and Receivers

The Spectrum Manager uses an Ethernet connection to deploy frequencies to networked components. For automatic network configuration, use a DHCP enabled Ethernet switch such as the AXT620 or an Ethernet router with DHCP service. Use multiple Ethernet switches to extend the network for larger installations.



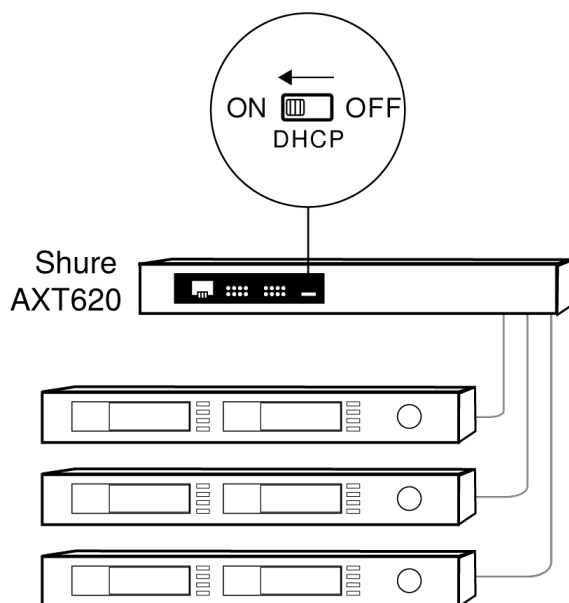

Multiple device network example using the Shure AXT620 Ethernet switch

**Note:** For smaller systems, connect the Spectrum Manager and receivers using the Ethernet ports on the back panel. The devices fall back to compatible addresses if the IP Mode is set to Automatic and there is no DHCP server.

## Automatic IP Addressing

1. If using a Shure AXT620 Ethernet switch, set the *DHCP* switch to *ON*.
2. Set the IP mode to automatic for all devices (*Util > Network > Mode > Automatic*)

## Manual IP Addressing

1. Connect the Spectrum Manager and receivers to an Ethernet switch.
2. Set the IP Mode to *Manual* for all devices:
  - Menu: *Util > Network*
  - Use the control wheel to set valid IP addresses for all devices. Set the subnet mask for all devices to the same value.

## Device Reset

Reset your device to restore factory settings.

1. Go to *Util > More > Reset All*.
2. Press *enter* to reset the device.

## Troubleshooting

Use only one DHCP server per network

All devices must share the same subnet mask

All devices must have the same level of firmware revision installed

Look for the network icons on the display of each device:

- If the icon is not there, check the cable connection and the LEDs on the network jack.

- If the LEDs are not on and the cable is plugged in, replace the cable and recheck the LEDs and network icon.

Use the Find All utility (*Util > Network > Find All*) to view devices on the network:

- The Find All report lists all devices on the network.
- Check the IP address for devices not shown in the Find All report to ensure that they are on the same subnet.

To check connectivity of WWB6 to the network:

1. Start WWB6 software and use Inventory view to see devices connected to the network.
2. If not, find the IP address from one of the devices on the network (such as an AXT400 receiver) and see if you can ping it from the computer running WWB6.
3. From a WINDOWS/MAC command prompt, type "ping IPADDRESS" of the device (e.g. "ping 192.168.1.100").
4. If the ping returns success (no packet loss), then the computer can see the device on the network. If the ping returns failure (100% packet loss), then check the IP address of the computer to ensure it's on the same subnet as the device.
5. If the pings are successful and the devices still do not show up in the WWB6 inventory, check to ensure all firewalls are either disabled or allow the WWB network traffic to pass to the application. Check that firewall settings are not blocking network access.

## Network Access Control

Access to Shure networked components can be controlled by setting a network PIN from Shure control software. Once a PIN has been set, the correct password must be entered from the software to make changes to component parameters.

Use the following steps to clear a network PIN:

1. From the home screen: *Util > Network > Access*.
2. Use the control wheel to select *Disabled*.
3. Press *enter* to save.

Tip: Performing a *Reset All* will clear a network PIN; however, all parameters will return to factory settings.

---

## RF Coordination Wizard

The Spectrum Manager includes a wizard to provide guided device and frequency configuration. Choose one of the following setup task options:

### *All New*

Use the *All New* option for initial RF coordination.

- Finds receivers and other devices on the network to manage
- Scans the RF spectrum for available frequencies
- Calculates a compatible frequency list (CFL) to match the needs of the networked devices
- Deploys frequencies to the managed devices

### *Update Freqs*

Use the *Update Freqs* option to refresh the frequencies for an existing wireless system.

- Scans the RF spectrum for available frequencies
- Calculates the compatible frequency list (CFL) to match the needs of the networked devices
- Deploys frequencies to the managed devices

## Update Devices

Use the *Update Devices* option when adding new devices to a wireless system.

- Finds devices on the network to manage
- Deploys frequencies from the existing compatible frequency list (CFL) to the managed devices

## Using All New Wizard Option for System Setup

The following example shows the steps for initial RF coordination using the *All New* wizard option. Use the *Update Freqs* or *Update Devices* wizard options to coordinate an existing wireless system.

1. From the home menu screen choose Wizard and select the *All New* option.
2. The *Found Channels* screen displays the frequency band and model of devices on the network. Press *Next*.
3. Press the control wheel to place a checkmark in the box next to the *Device ID*. Use the control wheel to select other devices or press *Add All*. Press *Flash* to identify a specific device in the list. Press *Next* when finished.
4. Mute all transmitters. Press *Next*.
5. Allow the scan to complete.

The RF plot is displayed in the data window. Press *Next*.

6. Allow the CFL calculation to complete.
7. Press *Deploy* to assign frequencies to the network devices.

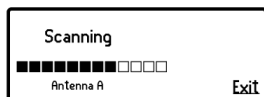
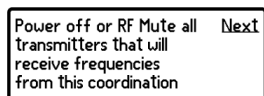
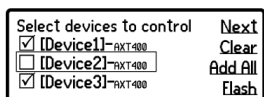
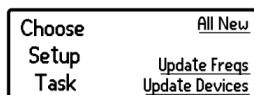

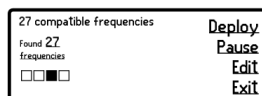
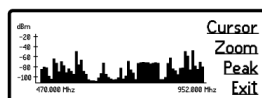

Writing to Hardware

## Exclusions

Most RF environments contain frequencies where it is not desirable to operate wireless equipment, such as those reserved for local broadcasts, public safety, or other users. Exclusions can be entered into the Spectrum Manager to prevent it from including these frequencies in its calculation of a compatible frequency list.

### Entering Exclusions

1. Menu: *CFL > New > Exclusions*

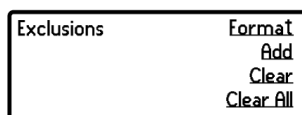

2. Press the menu button next to the *Add* option.
3. Press the control wheel to highlight *TV*, *Start*, or *Stop*:
  - To exclude a single frequency, set the values for the *Start* frequency and the *Stop* frequency to the same value
  - To exclude a range of frequencies, use the *Start* and *Stop* values to define the frequency range
  - To exclude a TV channel, use the control wheel to set the channel number
4. When finished, press *ENTER* to save changes.

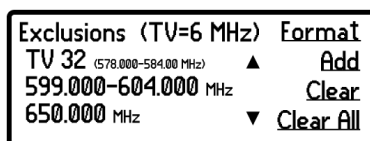

In this example, TV channel 32, the range of 599.00 to 604.000 MHz, and 650.000 MHz will be excluded from the compatible frequency calculation.

# Event Log

The event log records the actions of the Spectrum Manager and other devices it manages, as listed below. The log stores up to 150 events. The start of an event record is indicated with an asterisk (\*). The most recent events appear at the top of the log. Use the control wheel to scroll through the list of events. When the storage limit is reached, the oldest events are overwritten.

**Note:** A power cycle or firmware update will clear the event log.

Frequencies:

- Backup frequency degraded
- Backup frequency upgraded
- Frequency served to [channel name]
- Scan Stored

Managed Devices:

- [Device ID] goes off-line
- [Device ID] comes on-line
- [Device ID] removed
- [Device ID] added
- Transmitter [Tx] profile changed

Compatible Frequency List (CFL):

- CFL cleared
- New frequency added
- Frequency deleted
- Frequency value changed
- Frequency type changed
- CFL deployed
- New CFL calculated

Exclusions:

- Exclusion threshold changed
- Exclusion added (frequency or range)
- Exclusion cleared (frequency or range)

---

## Spectrum Monitoring

The Spectrum Manager has built-in tools to provide an excellent resource for examining, tracking, and troubleshooting the RF spectrum.

## Backup Frequency Monitoring

During operation, the data screen tracks the status of frequencies available for Axient channels in the system. The total number of frequencies available for each band are displayed, including real-time status of in-use and backup frequencies. Backup frequencies which have been degraded by the monitoring function are removed from the count of *Ready* frequencies.

Axient Frequency Monitoring					More
Band	G1	H4	J5	L3	
In Use	8	4	10	6	
Ready	10	6	4	12	

- *In Use* = frequencies that are deployed to Axient components including off-line devices
- *Ready* = frequencies that are open and available for use as backups or for other components
- *More* = select to view additional frequency bands

## Listen

Use this feature to monitor the FM demodulated signal at a selected frequency.

Menu: *Manual* > *Listen*

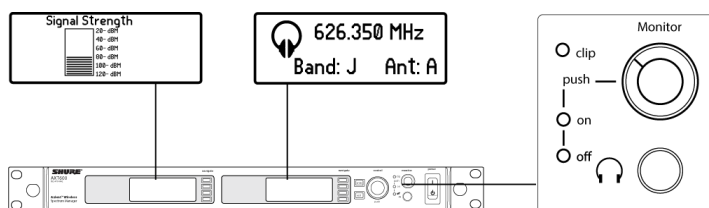

- Use the control wheel to select the frequency and antenna for monitoring.
- The data display shows the signal strength of the selected frequency.
- The menu display shows the selected frequency and antenna.
- The *Listen* feature can also be accessed from the *CFL* > *Edit* menu, allowing easy cueing of frequencies that are in use or backups.

## Scanning

Performing a spectrum scan creates a plot of RF activity on the data display. Use the *Cursor*, *Zoom*, and *Peak* tools to examine a specific area of the plot. The *Store* option allows for 2 plots of scan data to be saved by the Spectrum Manager for reference or for CFL calculation. Scans initiated from the Spectrum manager menu cover the entire tuning range. The Frequency Plot tool in Wireless Workbench software can be used to scan a subset of this range and provides options for step size and resolution bandwidth.

Sweep: Single Start  
 Peak Hold: Off  
 Exclusion Threshold > 85- dB Recall  
Store

Scanning

■■■■■■■■■■□□□□

Antenna A Exit

Menu: *Manual* > *Scan*

1. Set the following modes:
  - *Sweep* = *Single* or *Continuous*
  - *Peak Hold* = *Off* or *ON*

- *Exclusion Threshold* = The Spectrum Manager excludes scanned frequencies above this value from the Compatible Frequency List calculation. The threshold can be viewed during edit on the *Scan Data* display.
2. Press *Start* to begin scanning. Scan progress is shown on the display. When finished press *Store* to save a scan. Select *Recall* to access a stored scan. The recalled scan will overwrite the current scan data.

The RF plot is shown on the Data Display screen.

## Cursor Tool

*Cursor* adds a movable vertical dashed line placed on the RF plot. Use the control wheel to position the *Cursor* at any point in the plot.

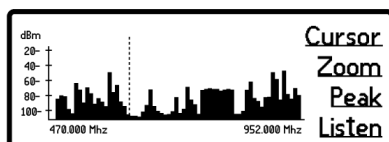

The frequency value and signal strength for the selected point are displayed at the top of the plot.

## Zoom Tool

*Zoom* magnifies RF plot to allow for detailed analysis of a portion of the spectrum.

Use *Zoom* to identify individual frequencies in crowded RF environments.

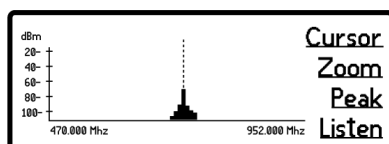

## Peak Tool

*Peak* enables the cursor to only select the highest peaks of the RF plot.

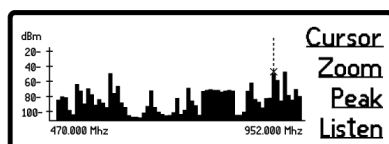

*Peak* provides a quick way to identify the strongest signals in the RF plot.

## Setting the Fan Speed

The cooling fan has the following speed options:

- *Low Speed* = fan is always on, at a lower speed for quiet operation
- *High Speed* = fan is always on, at a higher speed for maximum cooling
- *Automatic* = fan will operate only when the internal temperature becomes too warm.

Note: Speed may switch from Low to High if additional cooling is needed to protect the component.

1. From the home screen select *Util* > *More* > *Fan*.
2. Rotate the control wheel to select a speed option.
3. Press *Enter* to save.

## Firmware Updates

Firmware is embedded software in each component that controls functionality. Periodically, new versions of firmware are developed to incorporate additional features and enhancements. To take advantage of design improvements, new versions of the firmware can be uploaded and installed using the Firmware Update Manager tool available in WWB6 software. Firmware is available for download from <http://www.shure.com/wwb>.

## Specifications

### RF Tuning Frequency Range

470–865, 925–952 MHz

### RF Tuning Step Size

25, 200, 1000 kHz

### Noise Floor

Resolution Bandwidth

<b>25 kHz</b>	-110 dBm
<b>200 kHz</b>	-100 dBm
<b>1000 kHz</b>	-90 dBm

### Image Rejection

>110 dB, typical

### Spurious Response

<-100 dBm, typical

### Ultimate Quieting

>90 dB, A-Weighted

### Dimensions

44 mm x 483 mm x 366 mm (1.7 in. x 19.0 in. x 14.4 in.) H x W x D

### Weight

5.5 kg (12.0 lbs)

### Housing

Steel; Extruded aluminum



## Power Requirements

100 to 240 V AC, 50–60 Hz

## Current Drain

*referenced at 120 V AC*

0.8 A RMS

## Operating Temperature Range

-18°C (0°F) to 63°C (145°F)

## Storage Temperature Range

-29°C (-20°F) to 74°C (165°F)

## Scan Time

The Spectrum Manager scans the entire RF tuning frequency range in 64 seconds using 8 scanning modules in parallel. Scan time per 60 MHz may be less for specified ranges that allow scanning modules to work in parallel.

Step Size	Maximum Scan Time per 60 MHz
25 kHz:	48 seconds
*200 kHz:	7 seconds
*1000 kHz:	1 second

*\*Available only with WWB6 control*

## RF Input

### Connector Type

BNC

### Configuration

Unbalanced, Active

### Impedance

50  $\Omega$

### Maximum Input Level

-20 dBm

### Bias Voltage

12 V DC, 150 mA (300 mA maximum)

## Cascade Output

### Connector Type

BNC

## Configuration

Unbalanced, Active

## Impedance

50  $\Omega$

## Insertion Loss

<5 dB

## Monitor Audio Output

### Audio Frequency Response

40–18 kHz,  $\pm 3$  dB

### Configuration

Unbalanced mono, 1/4 in. Output (will drive stereo phones)

### Impedance

50  $\Omega$

### Maximum Signal Level

*45 kHz max. deviation*

1 W @ 63  $\Omega$

### Pin Assignments

<b>Tip</b>	audio +
<b>Ring</b>	audio +
<b>Sleeve</b>	ground

## Networking

### Power over Ethernet (PoE)

50 V DC, Class 1

### Network Interface

Dual Port Ethernet 10/100 Mbps

### Network Addressing Capability

DHCP or Manual IP address

## Accessories

### Furnished Accessories

<b>1-foot Coaxial Cascade Cable (2)</b>	95N2035
---	---------

IEC AC Power Cable (1)	95A9128
IEC AC Extension Cable (1)	95A9129
Shielded 3-foot Ethernet Cable (1)	C803
Shielded 8-inch Ethernet Jumper Cable (1)	C8006
Hardware Kit (1)	90XN1371
22-inch Coaxial Cable* (1)	95B9023
33-inch Coaxial Cable* (1)	95C9023

\* with integrated bulkhead for front mounting antennas.



## Information to the user

This device complies with part 15 of the FCC Rules. Operation is subject to the following two conditions:

1. This device may not cause harmful interference.
2. This device must accept any interference received, including interference that may cause undesired operation.

**Note:** This equipment has been tested and found to comply with the limits for a Class B digital device, pursuant to part 15 of the FCC Rules. These limits are designed to provide reasonable protection against harmful interference in a residential installation. This equipment generates uses and can radiate radio frequency energy and, if not installed and used in accordance with the instructions, may cause harmful interference to radio communications. However, there is no guarantee that interference will not occur in a particular installation. If this equipment does cause harmful interference to radio or television reception, which can be determined by turning the equipment off and on, the user is encouraged to try to correct the interference by one or more of the following measures:

- Reorient or relocate the receiving antenna.
- Increase the separation between the equipment and the receiver.
- Connect the equipment to an outlet on a circuit different from that to which the receiver is connected.
- Consult the dealer or an experienced radio/TV technician for help.

	This symbol indicates that dangerous voltage constituting a risk of electric shock is present within this unit.
	This symbol indicates that there are important operating and maintenance instructions in the literature accompanying this unit.

## IMPORTANT SAFETY INSTRUCTIONS

1. READ these instructions.
2. KEEP these instructions.
3. HEED all warnings.
4. FOLLOW all instructions.
5. DO NOT use this apparatus near water.
6. CLEAN ONLY with dry cloth.
7. DO NOT block any ventilation openings. Allow sufficient distances for adequate ventilation and install in accordance with the manufacturer's instructions.

8. DO NOT install near any heat sources such as open flames, radiators, heat registers, stoves, or other apparatus (including amplifiers) that produce heat. Do not place any open flame sources on the product.
9. DO NOT defeat the safety purpose of the polarized or grounding type plug. A polarized plug has two blades with one wider than the other. A grounding type plug has two blades and a third grounding prong. The wider blade or the third prong are provided for your safety. If the provided plug does not fit into your outlet, consult an electrician for replacement of the obsolete outlet.
10. PROTECT the power cord from being walked on or pinched, particularly at plugs, convenience receptacles, and the point where they exit from the apparatus.
11. ONLY USE attachments/accessories specified by the manufacturer.
12. USE only with a cart, stand, tripod, bracket, or table specified by the manufacturer, or sold with the apparatus. When a cart is used, use caution when moving the cart/apparatus combination to avoid injury from tip-over.



13. UNPLUG this apparatus during lightning storms or when unused for long periods of time.
14. REFER all servicing to qualified service personnel. Servicing is required when the apparatus has been damaged in any way, such as power supply cord or plug is damaged, liquid has been spilled or objects have fallen into the apparatus, the apparatus has been exposed to rain or moisture, does not operate normally, or has been dropped.
15. DO NOT expose the apparatus to dripping and splashing. DO NOT put objects filled with liquids, such as vases, on the apparatus.
16. The MAINS plug or an appliance coupler shall remain readily operable.
17. The airborne noise of the Apparatus does not exceed 70dB (A).
18. Apparatus with CLASS I construction shall be connected to a MAINS socket outlet with a protective earthing connection.
19. To reduce the risk of fire or electric shock, do not expose this apparatus to rain or moisture.
20. Do not attempt to modify this product. Doing so could result in personal injury and/or product failure.
21. Operate this product within its specified operating temperature range.

**WARNING:** Voltages in this equipment are hazardous to life. No user-serviceable parts inside. Refer all servicing to qualified service personnel. The safety certifications do not apply when the operating voltage is changed from the factory setting.

*Changes or modifications not expressly approved by Shure Incorporated could void your authority to operate this equipment.*

## WARNING FOR ALL EARPHONES!

For safe and correct use of earphones, read this manual before use. Keep the manual and safety information in a convenient place for future reference.

### WARNING

**LISTENING TO AUDIO AT EXCESSIVE VOLUMES CAN CAUSE PERMANENT HEARING DAMAGE. USE AS LOW A VOLUME AS POSSIBLE.** Over exposure to excessive sound levels can damage your ears resulting in permanent noise-induced hearing loss (NIHL). Please use the following guidelines established by the Occupational Safety Health Administration (OSHA) on maximum time exposure to sound pressure levels before hearing damage occurs.

<b>90 dB SPL</b> <b>at 8 hours</b>	<b>95 dB SPL</b> at 4 hours	<b>100 dB SPL</b> at 2 hours	<b>105 dB SPL</b> at 1 hour
<b>110 dB SPL</b>	<b>115 dB SPL</b>	<b>120 dB SPL</b>	

at ½ hour	at 15 minutes	Avoid or damage may occur
-----------	---------------	---------------------------

## WARNING

- Do not use when a failure to hear your surroundings could be dangerous, such as while driving, or when biking, walking, or jogging where traffic is present and accidents could occur.
- Keep this product and its accessories out of reach of children. Handling or use by children may pose a risk of death or serious injury. Contains small parts and cords that may pose risk of choking or strangulation.
- Set the volume level of the audio device to a minimum, and then after connecting the earphones, adjust the volume gradually. Sudden exposure to loud noises could cause hearing damage.
- Turn up the volume control only far enough to hear properly.
- Ringing in the ears may indicate that the volume level is too high. Try lowering the volume.
- If you connect these earphones to an airplane's sound system, listen at low levels so that loud messages from the pilot do not cause discomfort.
- Have your hearing checked by an audiologist on a regular basis. If you experience wax buildup, discontinue use until a medical professional has examined your ears.
- Failure to use, clean, or maintain earphone sleeves and nozzles according to manufacturer's instructions may increase the risk of sleeves detaching from the nozzle and becoming lodged in your ear.
- Prior to inserting the earphone, always recheck the sleeve to make sure it is firmly attached to the nozzle.
- If a sleeve becomes lodged in your ear, seek skilled medical assistance to remove the sleeve. Damage to the ear may be caused by non-professionals attempting to remove the sleeve.
- Do not attempt to modify this product. Doing so could result in personal injury and/or product failure.

## CAUTION

- Do not immerse in water, such as while taking a bath or washing your face, otherwise sound deterioration or failures may result.
- Do not use while sleeping as accidents may result.
- Use a slow twisting motion to remove the earphones. Never pull on the earphone cord.
- Stop using the earphones immediately if they are causing great discomfort, irritation, rash, discharge, or any other uncomfortable reaction.
- If you are currently receiving ear treatment, consult your physician before using this device.

**Note:** Use only with the included power supply or a Shure-approved equivalent.

## WARNING

- Battery packs may explode or release toxic materials. Risk of fire or burns. Do not open, crush, modify, disassemble, heat above 140°F (60°C), or incinerate.
- Follow instructions from manufacturer
- Do not short circuit; may cause burns or catch fire
- Do not charge with products other than those specified in this user guide.
- Dispose of battery packs properly. Check with local vendor for proper disposal of used battery packs.
- Batteries (battery pack or batteries installed) shall not be exposed to excessive heat such as sunshine, fire or the like

**Note:** Battery replacement to be performed only by Shure authorized service personnel.

Please follow your regional recycling scheme for batteries, packaging, and electronic waste.

# Certifications

Meets essential requirements of the following European Directives:

- WEEE Directive 2012/19/EU, as amended by 2008/34/EC
- RoHS Directive EU 2015/863

*Note: Please follow your regional recycling scheme for batteries and electronic waste*

Hereby, Shure Incorporated declares that the radio equipment is in compliance with Directive 2014/53/EU. The full text of the EU declaration of conformity is available at the following internet address: <http://www.shure.com/europe/compliance>

Authorized European representative:

Shure Europe GmbH

Headquarters Europe, Middle East & Africa

Department: EMEA Approval

Jakob-Dieffenbacher-Str. 12

75031 Eppingen, Germany

Phone: +49-7262-92 49 0

Fax: +49-7262-92 49 11 4

Email: [EMEAsupport@shure.de](mailto:EMEAsupport@shure.de)

Approved under the Declaration of Conformity (DoC) provision of FCC Part 15.

Certified by ISED in Canada under RSS-123.

**IC:** 616A-AXT600

**Industry Canada ICES-003 Compliance Label:** CAN ICES-3 (B)/NMB-3(B)

This device contains licence-exempt transmitter(s)/receiver(s) that comply with Innovation, Science and Economic Development Canada's licence-exempt RSS(s). Operation is subject to the following two conditions:

1. This device may not cause interference.
2. This device must accept any interference, including interference that may cause undesired operation of the device.

L'émetteur/récepteur exempt de licence contenu dans le présent appareil est conforme aux CNR d'Innovation, Sciences et Développement économique Canada applicables aux appareils radio exempts de licence. L'exploitation est autorisée aux deux conditions suivantes :

1. L'appareil ne doit pas produire de brouillage;
2. L'appareil doit accepter tout brouillage radioélectrique subi, même si le brouillage est susceptible d'en compromettre le fonctionnement.

*Note: EMC conformance testing is based on the use of supplied and recommended cable types. The use of other cable types may degrade EMC performance.*

**Changes or modifications not expressly approved by the manufacturer could void the user's authority to operate the equipment.**